

# Interface

## OEM

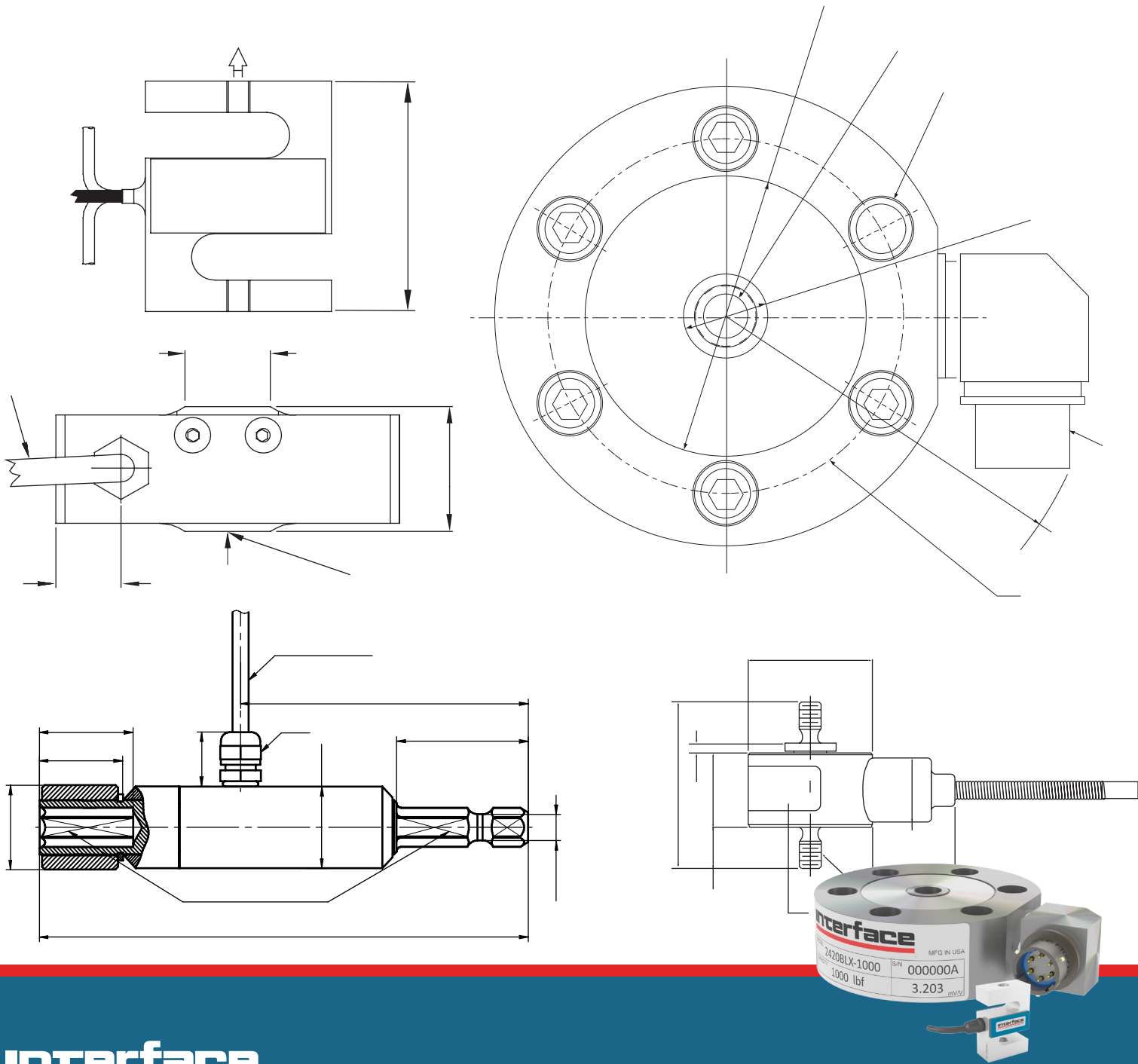

**Interface**  
FORCE MEASUREMENT SOLUTIONS

The World Leader in Force Measurement Solutions™

# Interface is a top pick by original equipment manufacturers, because we are an OEM that designs, engineers, builds, and tests the world's leading precision force and torque measurement solutions.

Interface is the partner you can trust to develop and manufacture the precise standards that are needed for every element we build that is essential in your application. We are experts in engineering Interface products for OEMs to sell as a stand-alone product or component within a product.

Whether you are looking for a uniquely designed precision load cell, torque transducer, multi-axis sensor, or miniature load cell, Interface has the capability and capacity to deliver high volume components. Specifications that are unique to a proprietary component is what we specialize in through our OEM solutions team. We can help with creating customized load pins, tension links, load shackles and instrumentation.

## We provide a range of products, services, and design capabilities in supporting OEM solutions, by designing and building custom solutions to fit your requirements, including:

- Products Requiring Sensor Technology Components
- Sensors Utilized to Measure Force, Weight or Torque
- Management of Test and Measurement Processes and Protocols
- Safety Requirements or Certifications for Quality
- Precision Performance Requirements and Testing

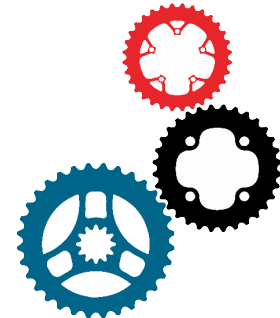

Our team is an extension to your team members, from product designers to test engineers, working together to get you exactly what you need. Throughout the entire process, from specification and design, to production and shipment- communication for your needs is our top priority. Our dedicated OEM team partners with our customers in engineering create solutions that are high quality, high performance, efficient, and affordable. Your success is our success.

## Interface takes on the role of your extended team member as:

- Supply Chain Manager for Interface Parts Integrator
- Design House Sharing Drawings and Specs
- Product Engineer, Designer, and Developer Resources
- Product Manager to Oversee Design and Build
- Production Team Members



Flexibility, dedicated resources, expertise, and OEM knowledge are key to our achievements in the limitless industries that are in need for OEM solutions from the best in sensor technologies, strain gages and customized components.

**We service many industries with OEM solutions, including:**

- Aerospace and Defense Contractors
- Robotics and Industrial Automation Makers
- Transportation Vehicles and Automotive Equipment
- Medical and Healthcare Devices
- Power, Energy and Mining Suppliers
- Computers and Electronic Technology Hardware Companies
- Agriculture Heavy Equipment and Materials
- Maritime Industry Sources
- Infrastructure Projects and Suppliers

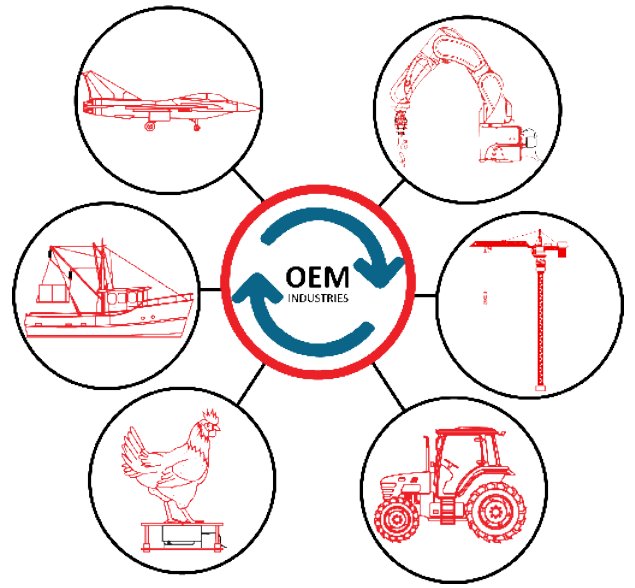

**Product Examples Available for High Volume OEM and Custom Solutions**



**2400 Standard Stainless Steel Low Capacity Load Cell**  
100 lbf to 5K lbf  
0.44 kN to 22 kN



**SSB Sealed Beam Load Cell**  
50 lbf to 10K lbf  
222 N to 44.48 kN



**SML Low Height S-Type Load Cell**  
5 lbf to 2,000 lbf  
22 N to 9 kN



**MSC Mini Column Compression Load Cell**  
? lbf to ? lbf  
? kN to ? kN



**SMT Overload Protected S-Type Load Cell**  
1.1 lbf to 450 lbf  
5 N to 2,000 N

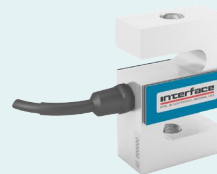

**SSM or SSM2 Sealed S-Type Load Cell**  
50 lbf to 10K lbf  
200 N to 50 kN

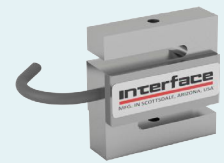

**SMA Miniature S-Type Load Cell**  
15 lbf to 200 lbf  
60 N to 900 N

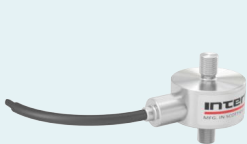

**WMC Miniature Sealed Stainless Steel Load Cell**  
5 lbf to 500 lbf  
22 N to 2,200 N



**TS17 Hex Drive Style Reaction Torque Transducer**  
1.7 lbf-in to 177 lbf-in  
0.2 Nm to 445 kN



**TS15 Female Square Drive to Flange Style Reaction Torque Transducer**  
17.7 lbf-in to 44.3K lbf-in  
2 Nm to 5K Nm



**MRT2P Miniature Overload Protected Flange Style Reaction Torque Transducer**  
17.7 lbf-in to 17.7 lbf-in  
0.2 Nm to 2 Nm

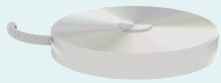

**LBS Miniature  
Compression Load Cell**  
5 lbf to 1K lbf  
0.02 kN to 4.45 kN



**LBM Compression  
Load Button Load Cell**  
25 lbf to 50K lbf  
0.11 kN to 222.4 kN



**MB Miniature Beam Load Cell**  
5 lbf to 250 lbf  
0.02 kN to 1.25 kN

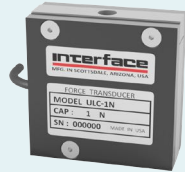

**ULC Ultra Low Capacity  
Load Cell**  
0.02 lbf to 0.45 lbf  
0.1 N to 2 N



**1516 2-Axial Torsion Load Cell**  
100 lbf, 50 lbf-in  
444.9 N to 5.6 Nm



**ConvexBT Load Button  
Load Cell**  
5 lbf to 1,000 lbf  
22.24 N to 4.44 N

## Ready to get started? Request an OEM Solution

It's never too early to start the conversations on how Interface can provide you a uniquely designed, reliable, accurate sensor technology that fits your exact requirements. Contact us today and let us know what you have in mind. We are ready to help. Our OEM Solutions Team can help you with your unique requirements. Our engineer and applications experts work with you to review your needs and discuss how we can help.

Contact us and tell us about your application, what are you looking to accomplish and if there are any special requirements we should be aware of in the design phase.

We will want to gather the specifications of product requirements, referencing any existing Interface product types and models, capacity, connectors and special part details related to the sensor or any other components. Estimating volumes and timing will also give us great insight into how we can support your exact requirements.

# Interface OEM

- 2-Axial Torsion
- Low Capacity
- Column Compression
- Compression Only
- Hex Drive Style
- Square Drive Style
- Flange Style
- Sealed
- Column and Rod End
- Stainless
- Load Button
- Overload Protected
- Load Washer
- Beam Type
- S-Type

*Interface force measurement OEM products are available in many design configurations for project designs requiring the highest performance.*

**To learn more about  
the Interface products  
or force measurement  
solutions call  
480-948-5555.**

**Interface is the world's trusted leader in technology, design and manufacturing of force measurement solutions. Our clients include a "who's who" of the aerospace, automotive and vehicle, medical device, energy, industrial manufacturing, test and measurement industries.**

Interface engineers around the world are empowered to create high-level tools and solutions that deliver consistent, high quality performance. These products include load cells, torque transducers, multi-axis sensors, wireless telemetry, instrumentation and calibration equipment.

Interface, Inc., was founded in 1968 and is a US-based, woman-owned technology manufacturing company headquartered in Scottsdale, Arizona.

**interface**  
FORCE MEASUREMENT SOLUTIONS

7418 East Helm Drive, Scottsdale, AZ 85260 ▪ 480.948.5555 ▪ [interfaceforce.com](http://interfaceforce.com)

Aufgrund laufender Weiterentwicklungen sind Änderungen der Spezifikationen vorbehalten. Alle Angaben vorbehaltlich Satz- und Druckfehler.

**nbn Austria GmbH**  
Riesstraße 146, 8010 Graz

Tel. +43 316 40 28 05 | Fax +43 316 40 25 06

**nbn**  
nbn@nbn.at | [www.nbn.at](http://www.nbn.at)